

➤ Instructions

Thule Caprock

S/M/L/XL/TB Short/TB Long/XXL

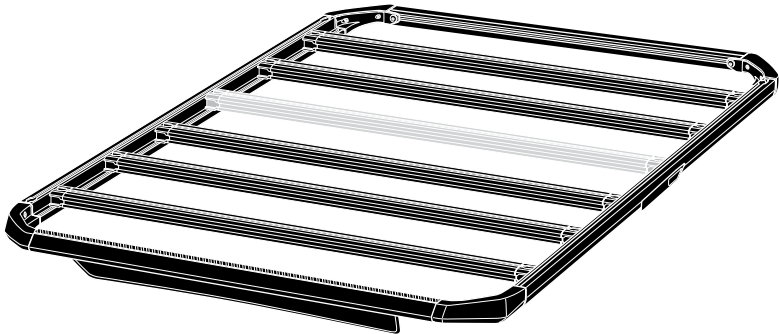

- EN** Platform for roof-mounted racks
- FR** Plateforme pour barres de toit
- ES** Plataforma para barras de tejadillo
- DE** Plattform für Dachgepäckträger
- NL** Platform voor dakdragers
- PT** Plataforma para barras de tejadilho
- IT** Piattaforma per portapacchi da installare sul tetto
- SV** Plattform för takmonterade räckor
- DK** Plattform til tagbøjler
- NO** Plattform til takmonterte stativer
- FI** Katolte asennettaviin telineisiin soviet alusta
- IS** Pallur fyrir grindur á þak
- ET** Katusele paigaldatavad koormakorvid
- LV** Uz jumta bagāžniekiem uzstādāmi kravas grozi
- LT** Ant stogo tvirtinamų skersinių krepšiai
- RU** Корзины для багажников
- UK** Кошки для багажників для даху
- PL** Kosze do bagażników dachowych
- CS** Koše na nosiče pro montáž na střeche
- HU** Tetőre szerelhető szállítókosarak
- RO** Bare tip plasă pentru suport montat pe acoperiș
- SK** Koše na strešné nosiče
- SL** Košare za strešne prtljajznike
- BG** Кошници за релси, монтирани върху покрива

- HR** Košare za krovne nosače
- EL** Καλάθια για ράβδους οροφής
- TR** Araç üstüne bağlanan rafalar için sepetler
- MT** Bakul untuk rak yang dipasang pada bumbung
- HE** ערסה לגג הרכב
- AR** سلات للحوامل المثبتة على السقف
- ZH (CN)** 用于车顶架的车顶筐
- ZH (TR)** 車頂架專用籃
- JA** ルーフマウント型ラック用バスケット
- KO** 루프 장착 랙 바스켓
- TH** ตะกร้าสำหรับแร็คหลังคา
- MS** Baskets ghal xtillieri mmuntati fuq is-saqaf

CITY CRASH
Complies with ISO norm

ISO 11154-E

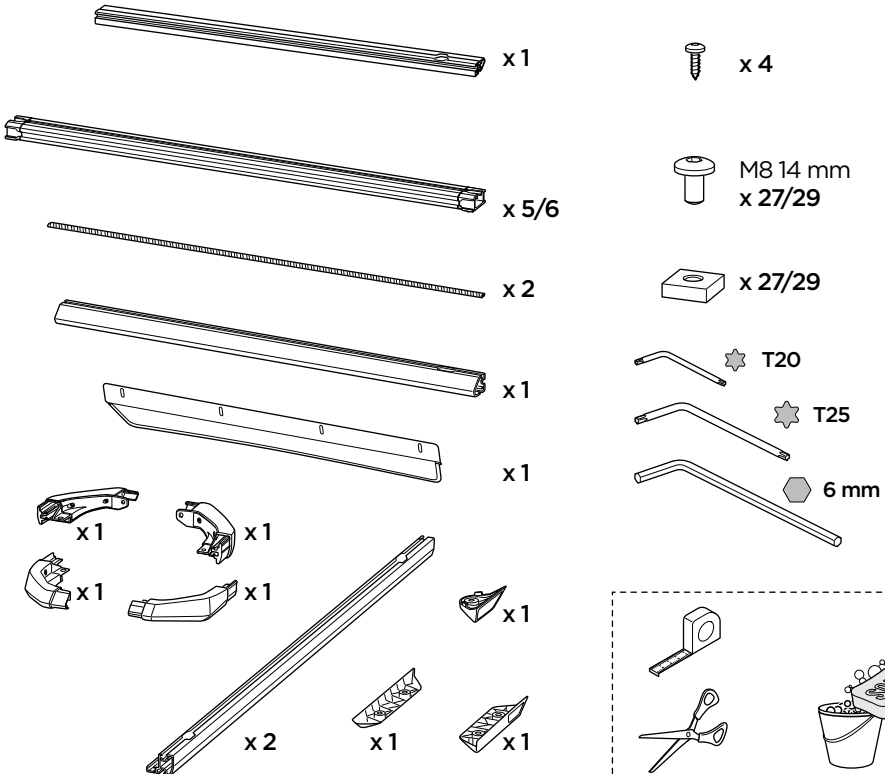
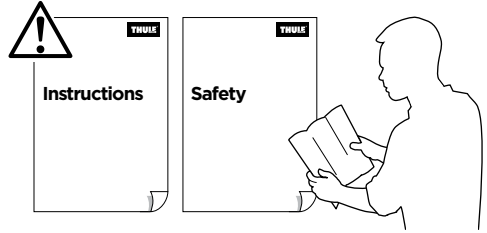



S, 611001: 22.2 kg/48.9 lbs

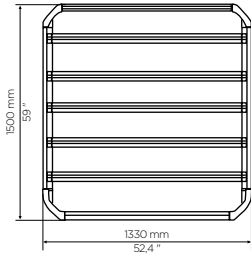

M, 611002: 24.2 kg/53.4 lbs

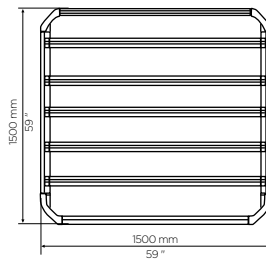

L, 611003: 28.2 kg/26.2 lbs

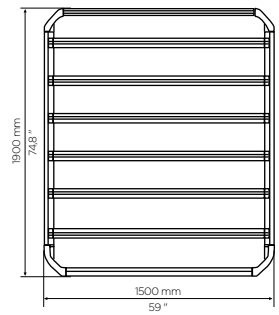

XL, 611004: 26.2 kg/57.8 lbs

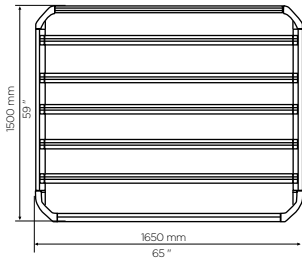

TB Long, 611005: 33.6 kg/74.1 lbs

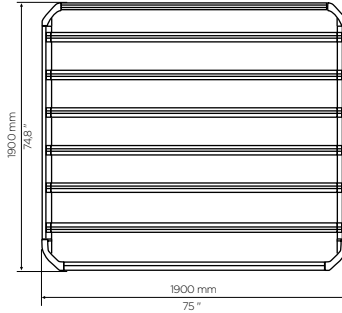



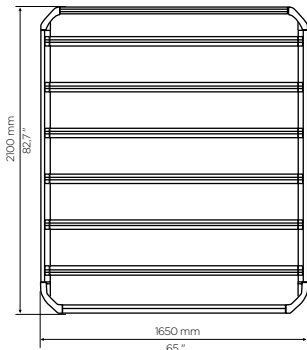

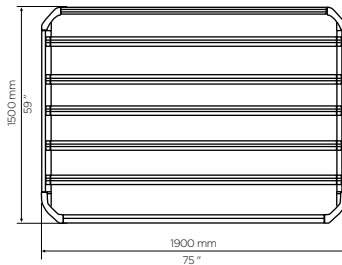

XXL, 611006: 31.0 kg/68.3 lbs



TB Short, 611015: 29.0 kg/63.9 lbs





	MAX  Kg/lbs				
Roof Rack	75/165	100/220	112.5/248	150/330	No Fit
Thule Evo Fixpoint 	X				
Thule Evo Flush Rail 	X				
Thule Rain Gutter 	X				
Thule Evo Raised Rail 		X			
Thule Caprock Crossbar Kit		X			
Thule Evo Fixpoint 		X			
Thule Rain Gutter 		X			
Thule Xsporter Pro Low		X			
Thule Xsporter Pro 500XT			X		
Thule Xsporter Pro Mid				X	
Thule Xsporter Pro Shift				X	
Thule Clamping System					X

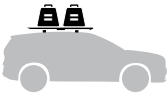

+



+



=

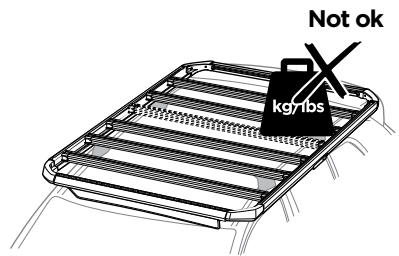
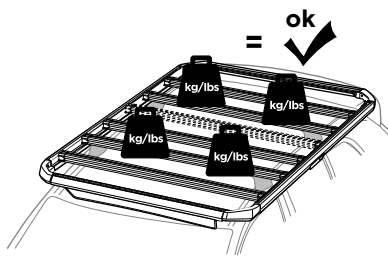
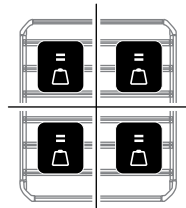
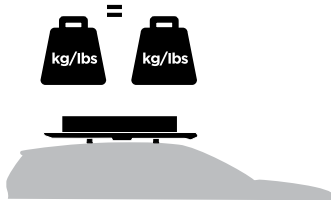
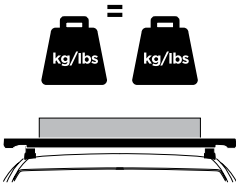
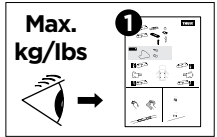



ok ✓

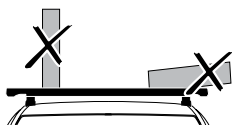

Not ok ✗

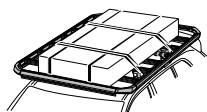
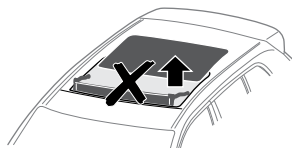
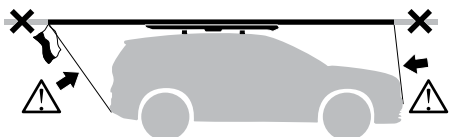
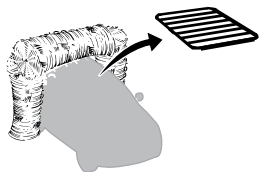
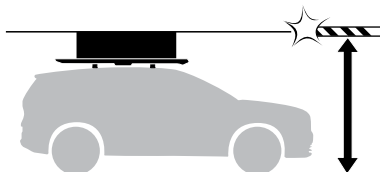
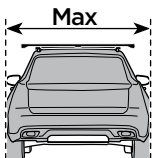
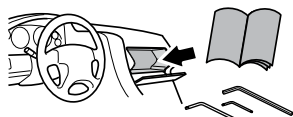
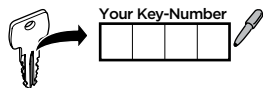

Ok



Not Ok

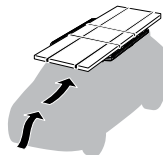

500 km/310 Miles



+

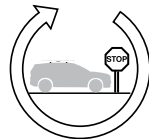

*2-3



EN Only a few turns

FR Quelques tours uniquement

ES Sólo algunas vueltas

DE Nur wenige Umdrehungen

NL Slechts enkele slagen

PT Apenas algumas voltas

IT Solo qualche giro

SV Endast några varv

DK Kun nogle få omgange

NO Bare noen få omdreininger

FI Vain muutama kierros

IS Aðeins nokkrir snúningar

ET Ainult mõni pööre

LV Tikai dažī apgrīzieni

LT Tik keli pasukimai

RU Только несколько оборотов

UK Лише декілька обертів

PL Wystarczy kilka obrotów

CS Pouze několik otáček

HU Csak néhány fordítás

RO Doar câteva rotiri

SK Len niekoľko otáčok

SL Le nekaj obratov

BG Само няколко завъртания

HR Samo nekoliko okreta

EL Μόνο λίγες περιστροφές

TR Yalnızca birkaç tur

MT Hanya beberapa putaran

HE רק מספר סיבובים

AR بعض دورات فقط

ZH (CN) 仅几圈

ZH (TR) 只需轉幾圈

JA わずか数ターン

KO 몇 번만 돌리면 됨

TH เพียงสองสามรอบ

MS Ftit dawriet biss

1

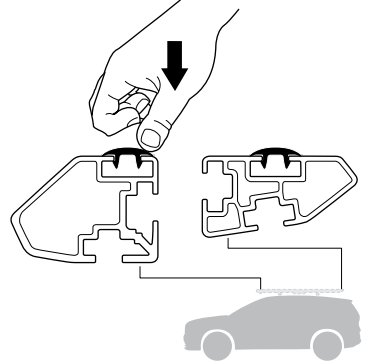
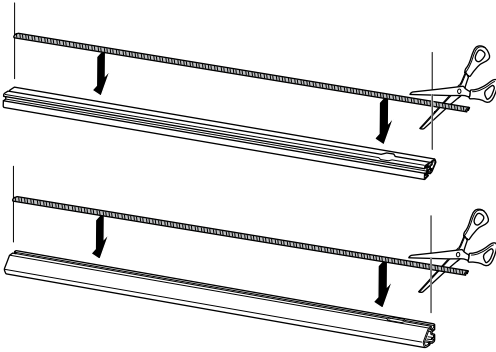
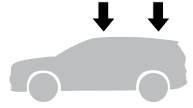
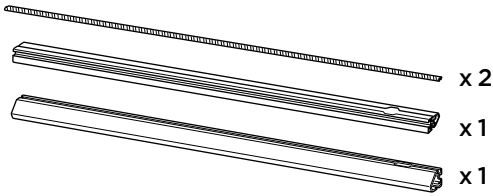

2

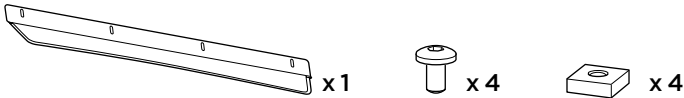

A

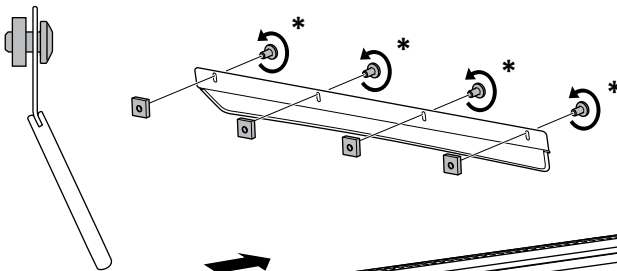

B

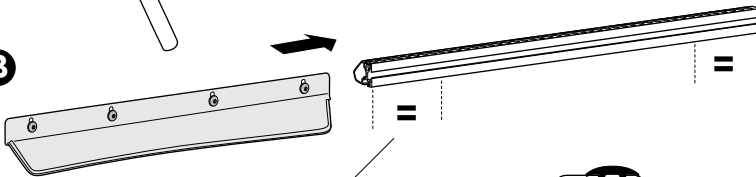





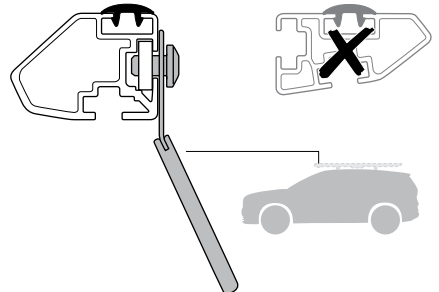

i

611001	80 mm / 3"
611002	80 mm / 3"
611003	80 mm / 3"
611004	80 mm / 3"
611005	205 mm / 8"
611006	80 mm / 3"
611015	205 mm / 8"



3

-  x1
-  x1
-  x1
-  x1
-  x1
-  x8
-  x8

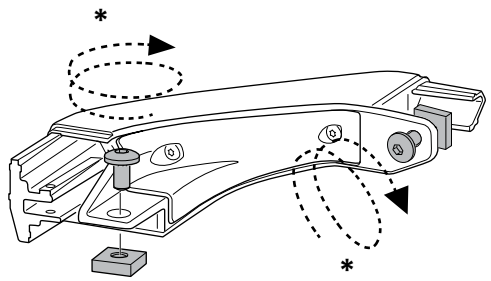

***2-3** 

4

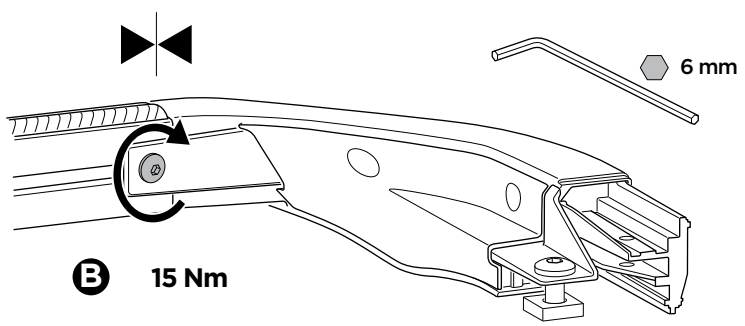
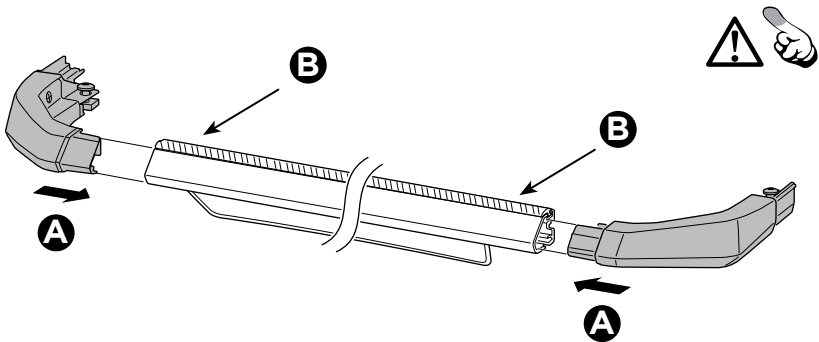

5

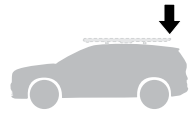
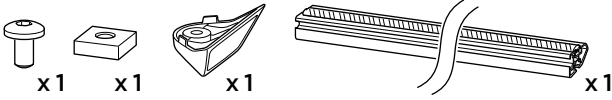

***2-3**

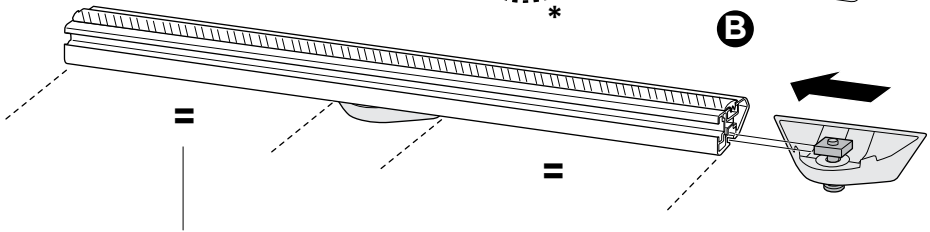
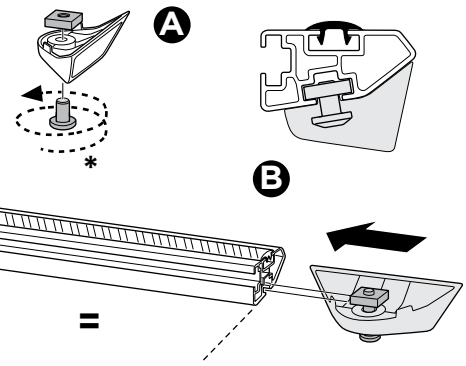

i

611001	466 mm / 18 3/8"
611002	551 mm / 21 11/16"
611003	551 mm / 21 11/16"
611004	626 mm / 24 5/8"
611005	751 mm / 29 9/16"
611006	626 mm / 24 5/8"
611015	751 mm / 29 9/16"

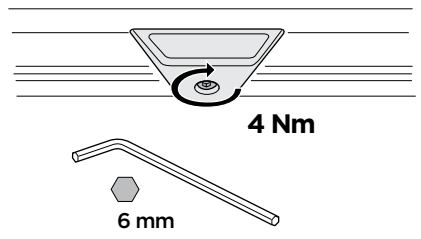

6

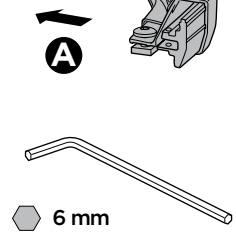
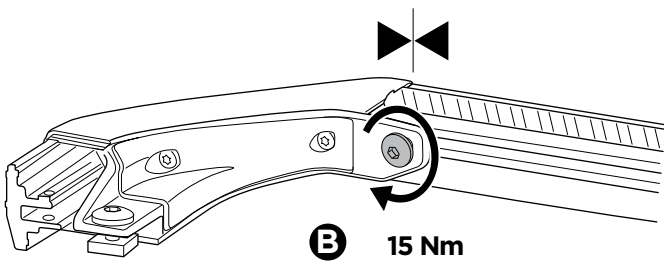
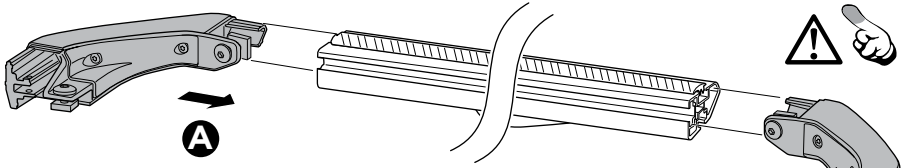

7

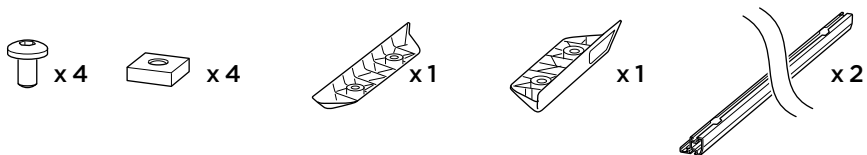

A

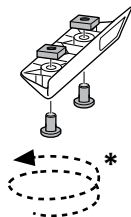

***2-3**

i

611001	407 mm / 16 1/3"
611002	407 mm / 16 1/3"
611003	607 mm / 23 7/8"
611004	407 mm / 16 1/3"
611005	607 mm / 23 7/8"
611006	707 mm / 27 13/16"
611015	407 mm / 16 1/3"

B

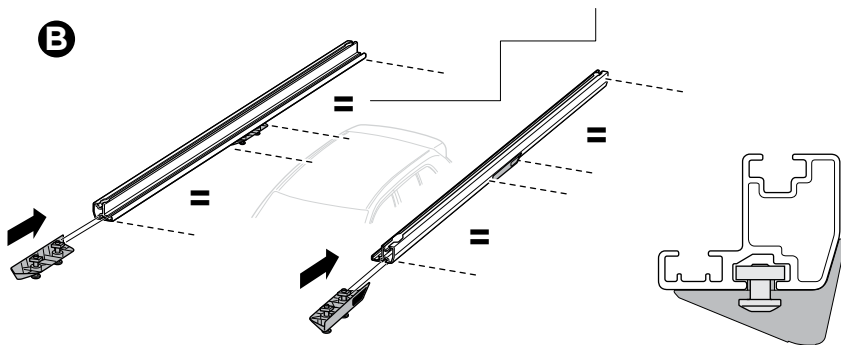

C

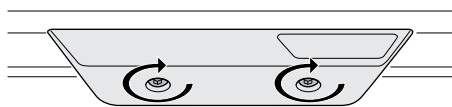

4 Nm

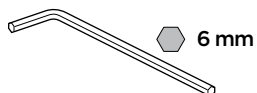

8

x 10/12

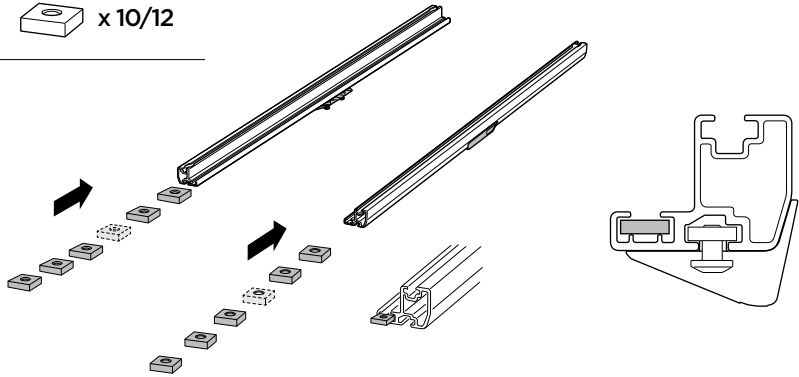

9

x 4

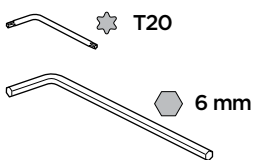
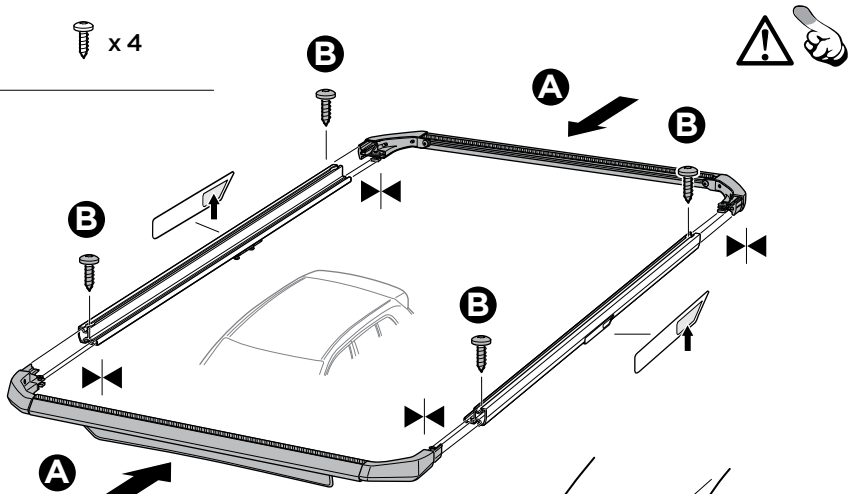

4 Nm
Torx T20

15 Nm
6 mm

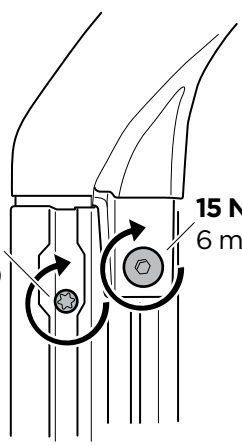

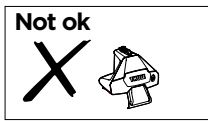
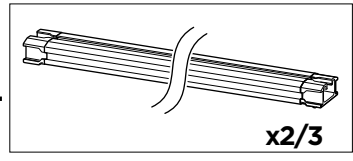
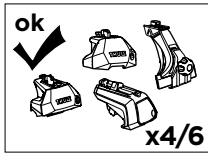
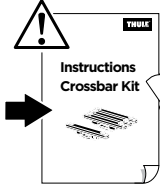
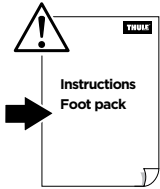

10

A

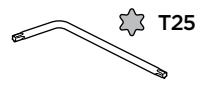
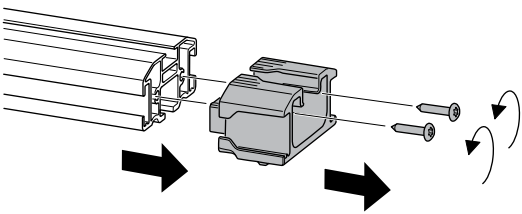

B

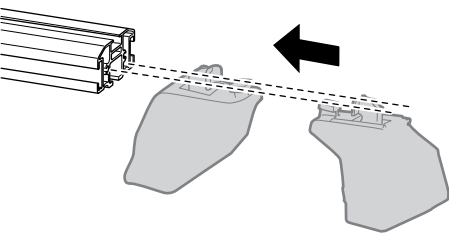

C

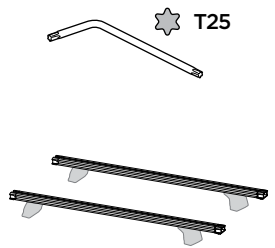
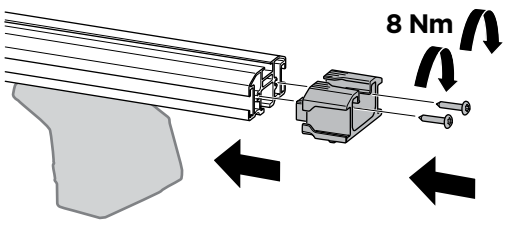

11

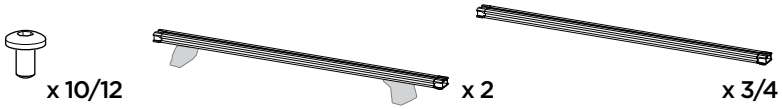

***2-3** ↻

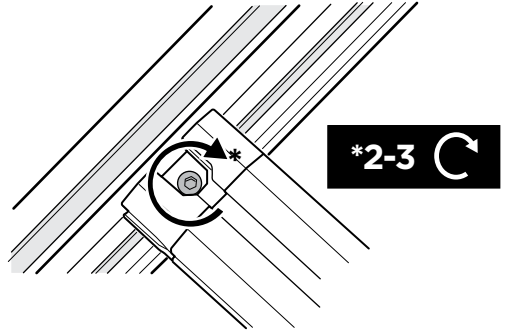
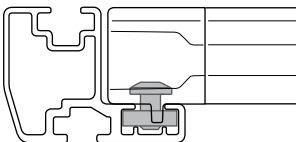
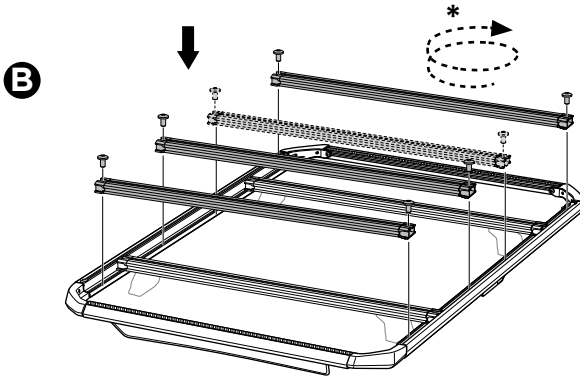
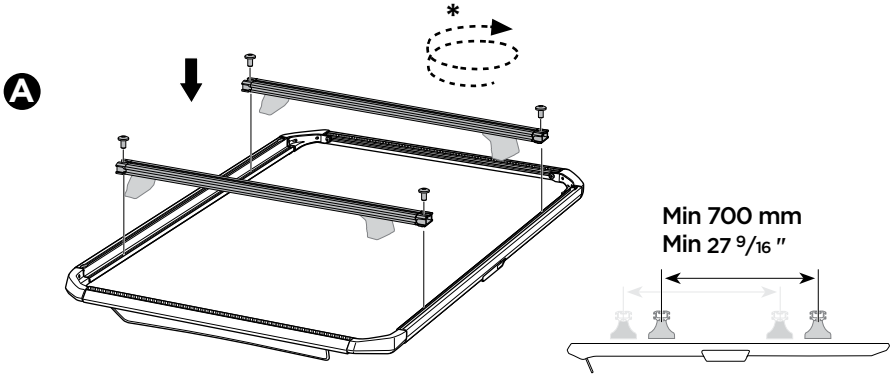

12

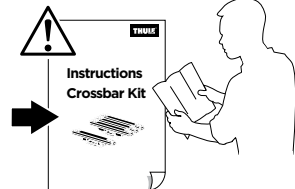
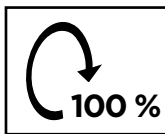
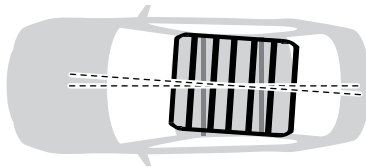
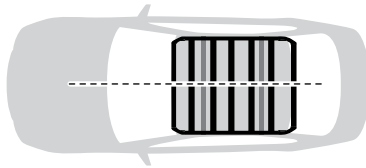
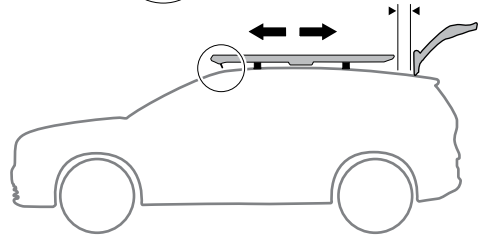
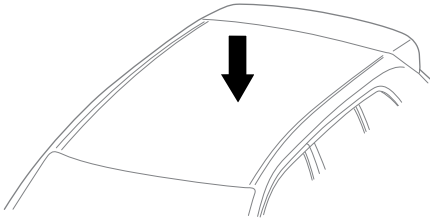
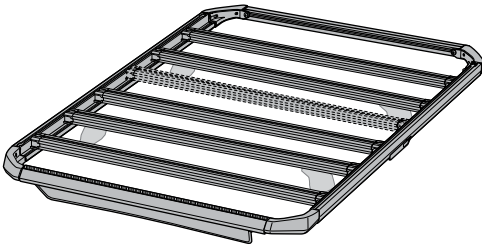
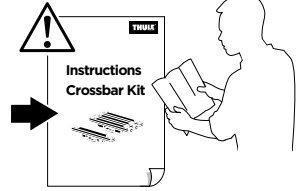
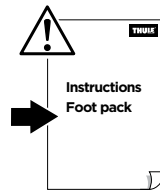
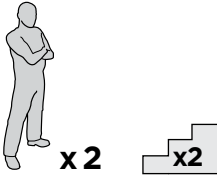

13

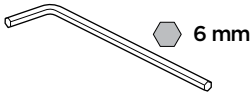
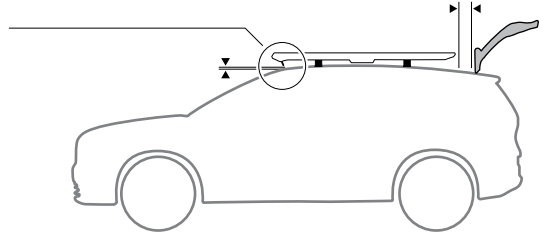
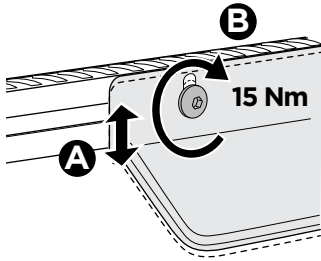
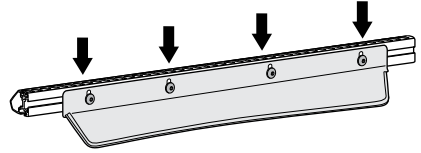
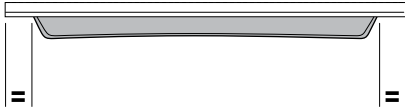

14

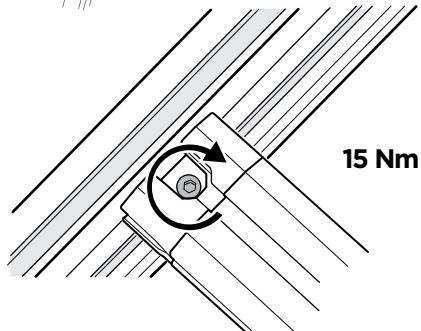
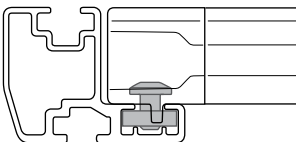
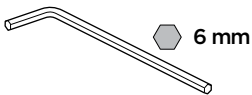
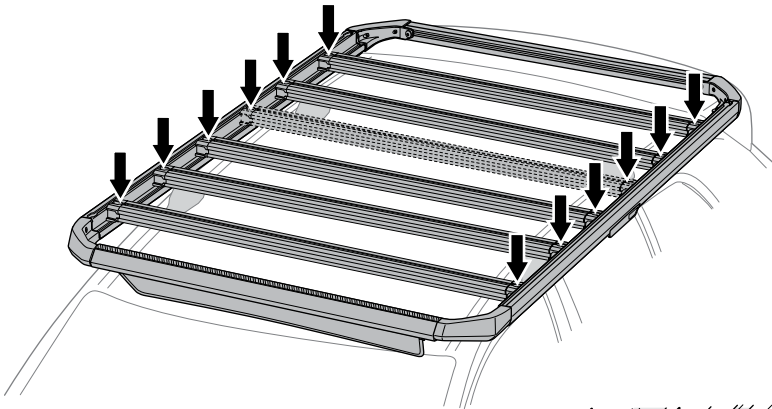

15

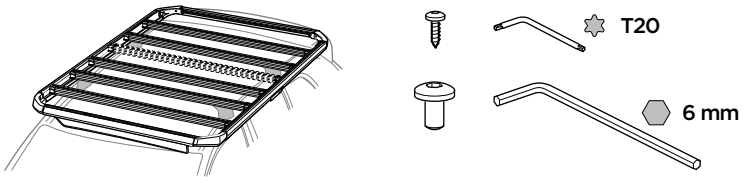
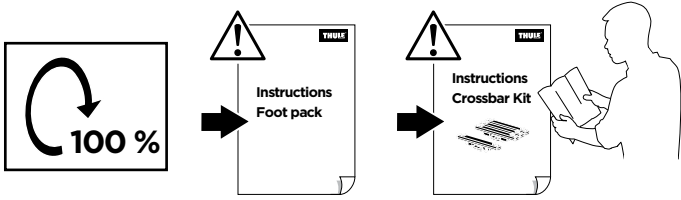

i

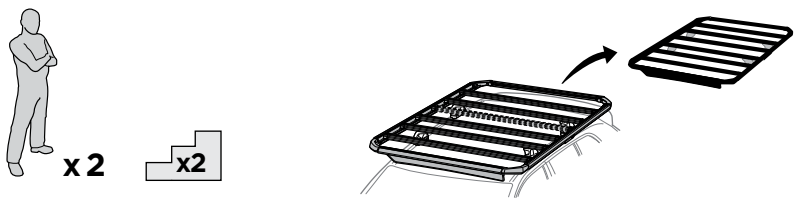

A

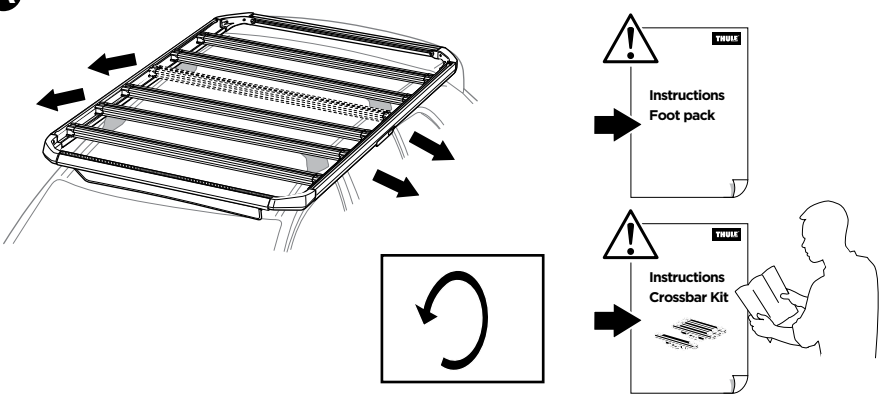

B

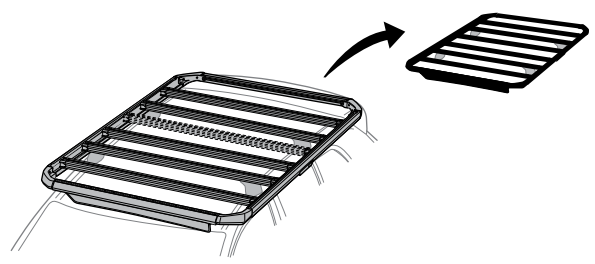

EN Accessories
FR Accessoires
ES Accesorios
DE Zubehör
NL Accessoires
PT Acessórios
IT Accessori
SV Tillbehör
DK Tilbehør

NO Tilbehør
FI Lisävarusteet
IS Aukabúnaður
ET Lisavarustus
LV Piederumi
LT Priedai
RU Аксессуары
UK Аксесуари
PL Akcesoria

CS Doplnky
HU Tartozékok
RO Accesorii
SK Príslušenstvo
SL Dodatki
BG Принадлежности
HR Dodaci
EL Εξαρτήματα
TR Aksesuarlar

MT Accessorji
HE אביזרים
AR ملحقات
ZH (CN) 附件
ZH (TR) 配件
JA アクセサリー
KO 액세서리
TH อุปกรณ์เสริม
MS Aksesori

Thule Caprock Crossbar Kit 611300

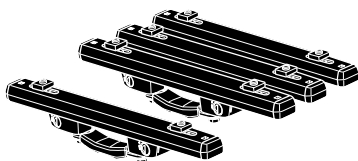

Thule Caprock Xsporter Pro Kit 611310

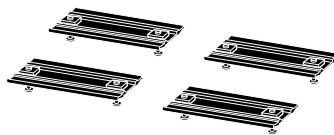

Thule Caprock Railing Kit 611201-611208

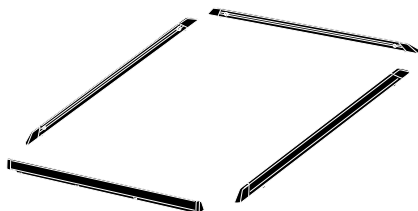

Thule Coverstrips 611320

